

ICOM

INSTRUCTION MANUAL

VHF FM TRANSCEIVER

IC-T21CP

UHF FM TRANSCEIVER

IC-T31CP

Icom Inc.

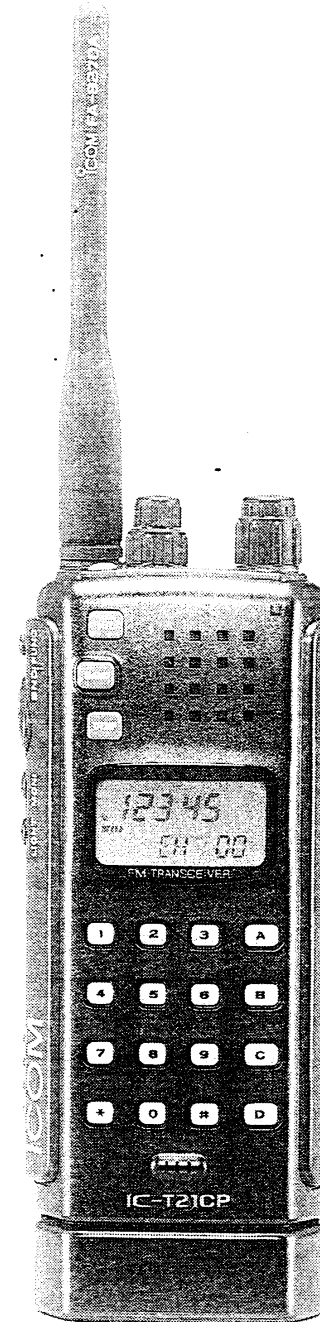

IMPORTANT

READ ALL INSTRUCTIONS carefully and completely before using the transceiver.

SAVE THIS INSTRUCTION MANUAL. This instruction manual contains important safety and operating instructions.

For telephone operation, the OPB (OPTION Board) is required. Otherwise, only talk around operation is available. Ask your system operator or Icom Dealer for details.

UNPACKING

- ① Handstrap 1
- ② Flexible antenna (FA-S270A) 1
- ③ Belt clip and screws 1 set

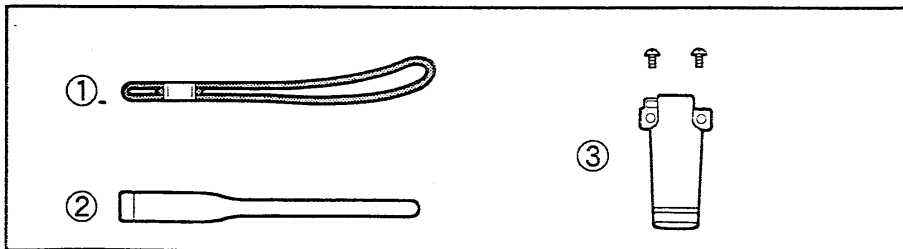

The BP-152 BATTERY PACK is attached to the transceiver.

CAUTIONS

NEVER connect the transceiver to an AC outlet. This connection will ruin the transceiver.

NEVER allow children to touch the transceiver.

DO NOT turn the power ON while a wall charger is connected to [DC 13.5V] on the top panel. This jack is used for charging only.

AVOID using or placing the transceiver in areas with temperatures below -10°C or above $+60^{\circ}\text{C}$.

AVOID placing the transceiver in direct sunlight.

BE CAREFUL! When transmitting for a long time at high output power, the rear panel will become hot.

BE CAREFUL! The use of non-Icom battery packs and chargers may impair transceiver performance and invalidate the warranty.

TABLE OF CONTENTS

IMPORTANT	i	4 TELEPHONE OPERATION	8-11
UNPACKING	i	■ Pre-operation	8
CAUTIONS	i	■ Calling	8
TABLE OF CONTENTS	ii	■ Answer back	9
1 PANEL DESCRIPTION	1-4	■ Output power selection	9
■ Front and side panels	1	■ Re-dialing	9
■ Keyboard	2	■ DTMF memory operation	10
■ Top and rear panels	3	■ Lighting	11
■ Function display	4	■ Battery voltage indication	11
2 ACCESSORY ATTACHMENT	5	5 TALK AROUND OPERATION	12-15
3 BATTERY PACK CHARGING	6-7	■ Talk around communication	12
■ Usable battery packs	6	■ Monitor function	13
■ Charging connections	6	■ Beep tones	13
■ Battery pack notes	7	■ Scan operation	13
■ Dry cell battery installation	7	6 PAGER AND CODE SQUELCH	14-15
		■ Code setting	14
		■ Code channel programming	14
		■ Pager operation	15
		■ Code squelch operation	15
		7 OPTIONS	16

PANEL DESCRIPTION

Front and side panels

FUNCTION SWITCH [FUNC]

When pushed and held, some other switches perform secondary functions. "Push [FUNC] + a switch" means "while pushing [FUNC], push the switch."

SEND SWITCH [SND]

- While in telephone operation: Push to call or to answer back to a call. Push again to end communicating. (pgs. 8, 9)
- While in talk around operation: Push to transmit and release to receive. (p. 12)

MONITOR SWITCH [MONI]

- While in telephone operation: No function.
- While in talk around operation: Monitors the channel. (p. 13)

LIGHT SWITCH [LIGHT]

Turns the lighting ON and OFF. (p. 11)

KEYBOARD (p. 2)

TRANSMIT/RECEIVE INDICATOR

- While in telephone operation: Lights up in red while communicating. (p. 8)
- While in talk around operation: Lights up in red while transmitting. Lights up in green while receiving. (p. 12)

HIGH/LOW SWITCH [H/L]

Selects high or low output power level. (pgs. 8, 12)

SPEAKER

BAND SWITCH [BAND]

No function.

DTMF SWITCH [DTMF]

Selects DTMF MEMORY mode. (p. 10)

FUNCTION DISPLAY (p. 4)

MICROPHONE

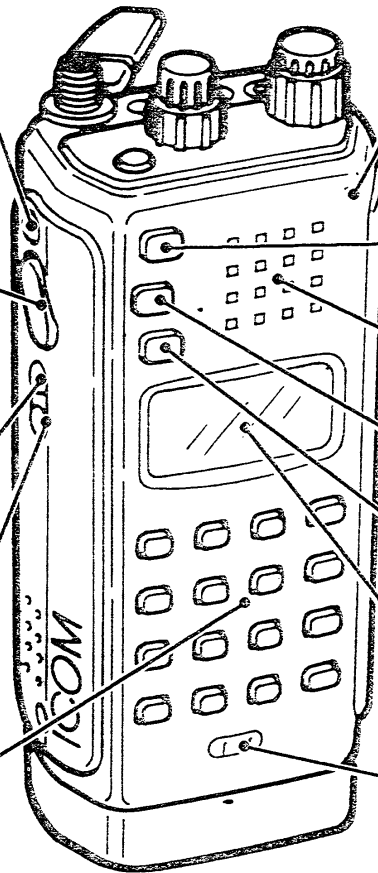

Keyboard

◇ While in telephone operation

Key	Function
(1) (2) (3) (4) (5) (6) (7) (8) (9) (*)(0)(#)	- Input a telephone number. (p. 8) - While in DTMF MEMORY mode: Select a DTMF memory channel. (p. 10)
(A)	- Cancels re-dialing function. (p. 9) - Exits DTMF MEMORY mode. (p. 10)
(C)	Cancels telephone number. (p. 8)
(D)	Allows you to re-dial. (p. 9)
FUNC ○ + (8)	While in DTMF MEMORY mode: Allows you to program a DTMF memory channel. (p. 10)

◇ While in talk around operation

Key	Function
(1) (2) (3) (4) (5) (6) (7) (8) (9) (*)(0)(#)	While in code channel setting display: Program a code channel. (p. 14)
FUNC ○ + (2)	Activates or cancels the pager or code squelch function. (p. 15)
FUNC ○ + (3)	While in code channel setting display: Sets a code channel for "receive inhibit" or "receive accept." (p. 14)
FUNC ○ + (5)	Selects code channel setting display for pager or code squelch. (pgs. 14, 15)
FUNC ○ + (8)	Selects SET mode to turn the beep tones ON or OFF. (p. 13)
FUNC ○ + (#)	Start the scan forward direction. (p. 13)
FUNC ○ + (*)	Start the scan reverse direction. (p. 13)
(A)	- Exits SET mode. (p. 13) - Cancels scanning. (p. 13) - Exits the code channel setting display. (pgs. 14, 15)

NOTE: For telephone operation, the OPB (OPTION Board) is required. Otherwise, only talk around operation is available. Ask your system operator or Icom Dealer for details.

ENGLISH

1 PANEL DESCRIPTION

■ Top and rear panels

CHARGING JACK

[DC13.5V]

Connects the optional BC-74A/E/D/V WALL CHARGER for regular charging. (p. 6)

CAUTION:

DO NOT turn the power ON while charging. This jack is used for charging only.

DO NOT connect the wall charger while operating with dry cell batteries using the optional BP-159 BATTERY CASE. Otherwise, battery leakage may occur.

ANTENNA CONNECTOR

SMA-type connector. Connects the supplied antenna. (p. 5)

POWER SWITCH [POWER]

- Turns the power ON and OFF. (p. 8)
- With -[FUNC] + [A] when turning the power ON: Selects talk around operation. (p. 12)

BATTERY PACK

RELEASE BUTTON (p. 7)

EXTERNAL SPEAKER AND

MICROPHONE JACKS [SP], [MIC]

Not used.

NOTE: DO NOT any equipment while telephone operation.

TUNING DIAL [DIAL]

- While in telephone operation: No function.
- While in talk around operation: Selects a channel. (p. 12)

VOLUME CONTROL [VOL]

Adjusts the audio level. (pgs. 8, 12)

SQUELCH CONTROL [SQL]

- While in telephone operation: No function.
- While in talk around operation: Adjusts the squelch level for noise mute. (p. 12)

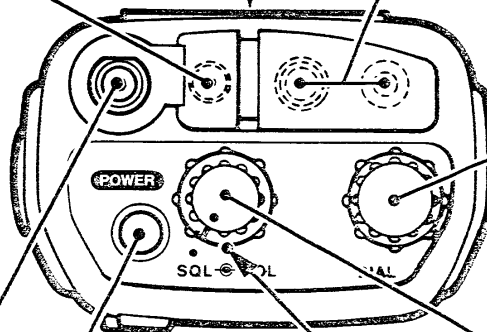

Function display

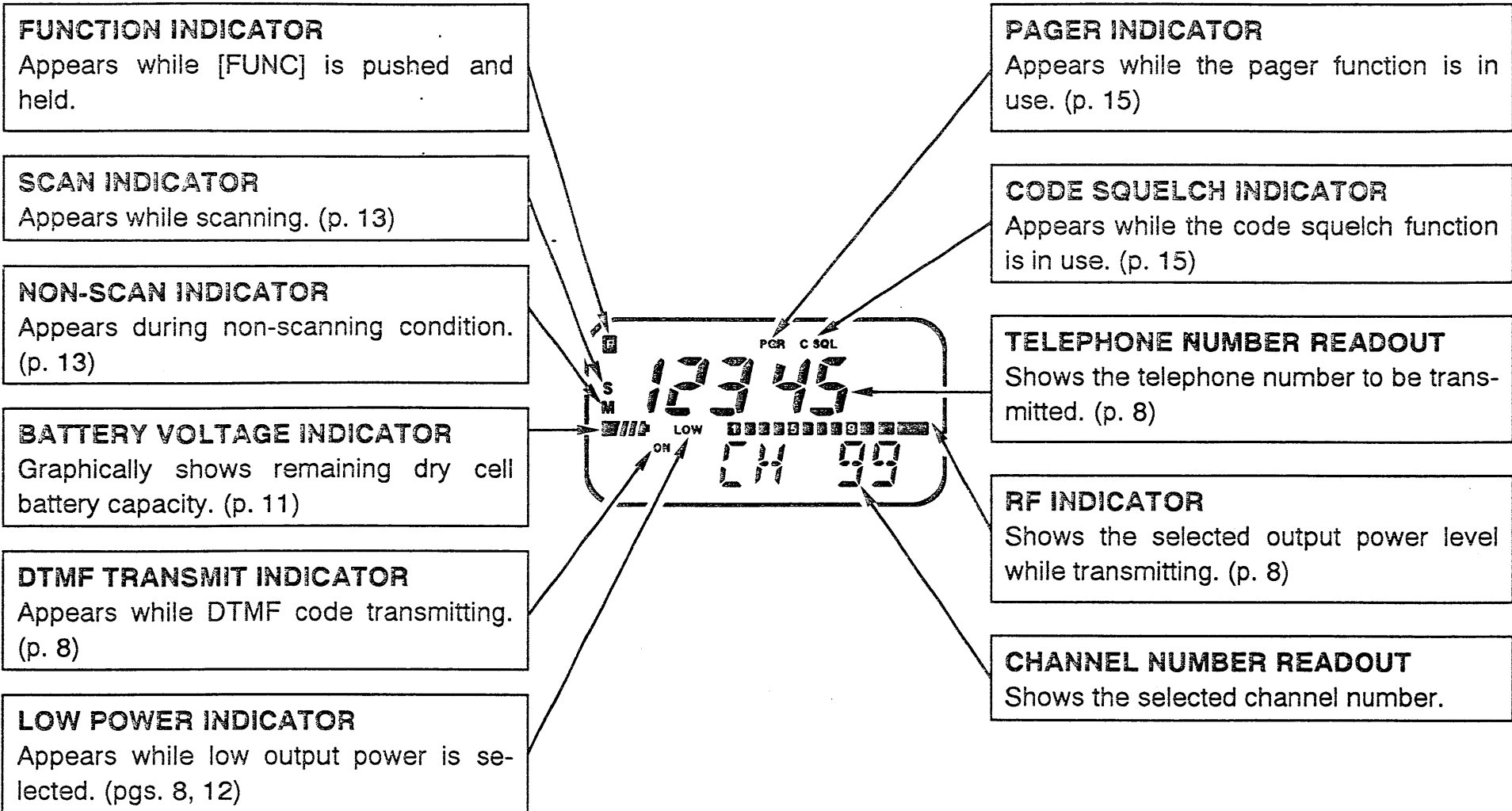

ENGLISH

2

ACCESSORY ATTACHMENT

◇ Antenna

Insert the supplied antenna into the antenna connector and screw down the antenna.

KEEP the jack cover attached when jacks are not in use to avoid bad contacts.

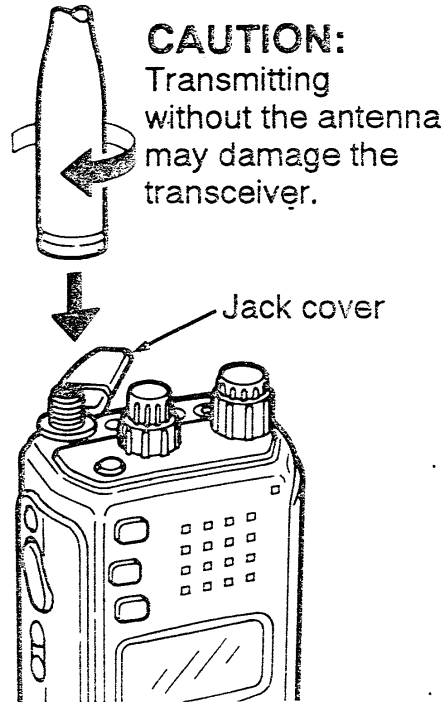

◇ Handstrap

Install the handstrap to the supplied belt clip. The handstrap facilitates carrying.

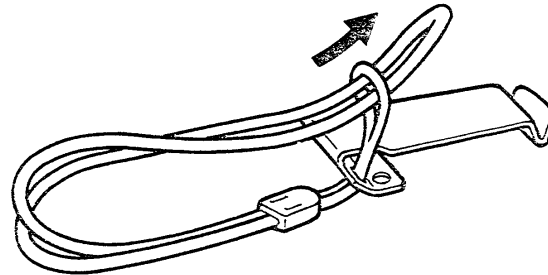

◇ Belt clip

Remove the plastic screws, then attach the belt clip with the supplied metal screws. Conveniently attaches to your belt.

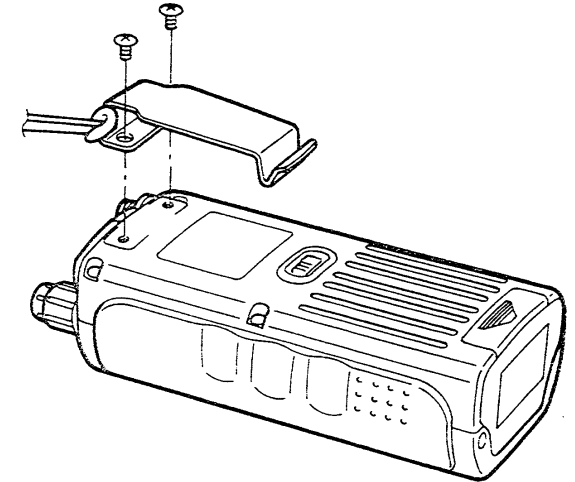

■ Usable battery packs

The transceiver accepts the BP-151, BP-152 BATTERY PACKS and BP-159 BATTERY CASE. (p. 16)

CAUTION: NEVER use the BP-153 BATTERY PACK. This 12 V battery pack will ruin the transceiver.

■ Charging connections

◇ Regular charging

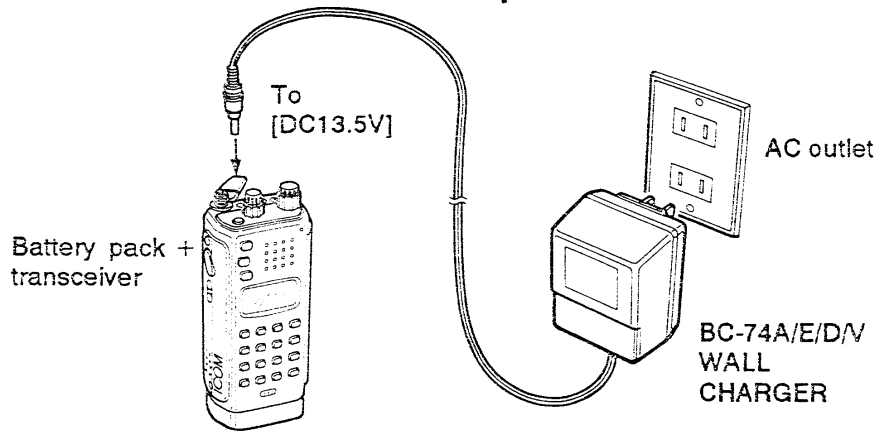

Charging period: 15 hrs.

NOTE:

- DO NOT turn the power ON while charging. [DC 13.5V] on the top panel is used for charging only.
- DO NOT connect the wall charger when the optional BP-159 BATTERY CASE is connected. Otherwise, battery leakage may occur.
- Disconnect the charger within 48 hrs. to prevent over charging.

◇ Rapid charging

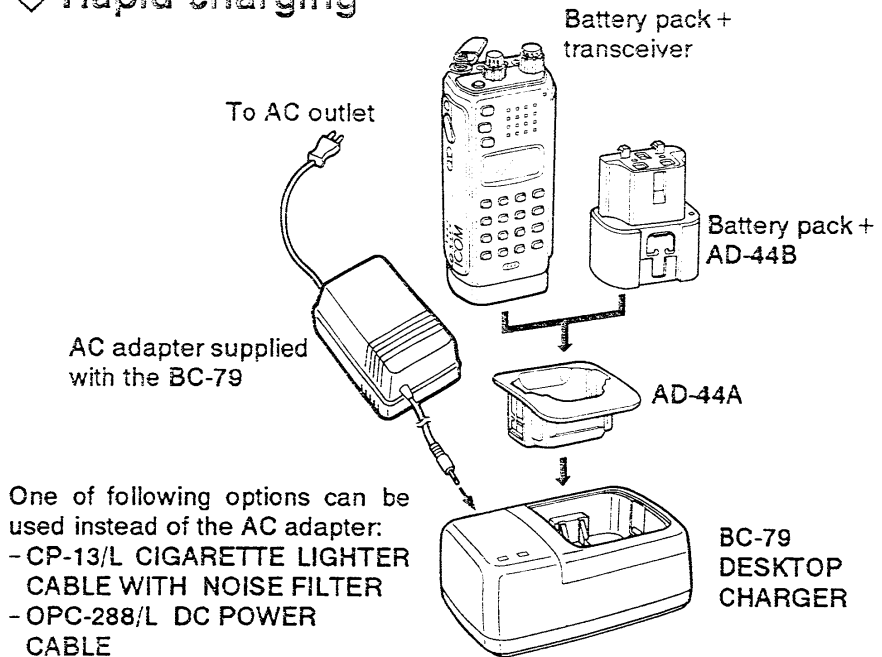

Charging period: BP-151 75 min. BP-152 70 min.

3 BATTERY PACK CHARGING

■ Battery pack notes

NEVER throw a battery pack into a fire.

NEVER expose the battery pack to water.

NEVER short the metal terminals.

NEVER attempt to charge the optional BP-159 BATTERY CASE when dry cell batteries are installed. Otherwise, battery leakage may occur.

Charging may not occur in extreme cold (under 0°C) or extreme heat (over + 40°C).

◇ Using your battery pack wisely

If a battery pack does not have enough capacity after charging, leave the transceiver's power ON overnight to discharge. Then, charge the battery pack again. If the capacity is still not enough, purchase a new battery pack.

Recharging can usually be performed 300 times, but battery life can be lengthened to about 500 recharges as follows:

- **AVOID** over charging.
- Use the battery pack until it becomes almost completely exhausted under normal conditions. Charge as soon as transmitting becomes impossible.

■ Dry cell battery installation

The optional BP-159 BATTERY CASE allows you to operate the transceiver using dry cell batteries.

- ① Remove the battery case from the transceiver.

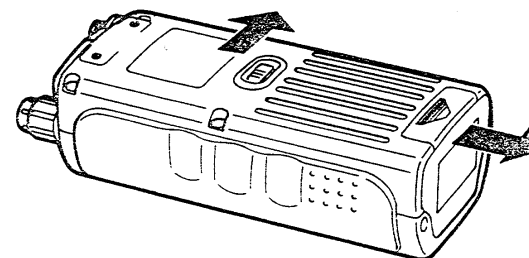

- ② Install AA (R6) × 4 dry cell batteries.
 - Pay attention to the polarities.

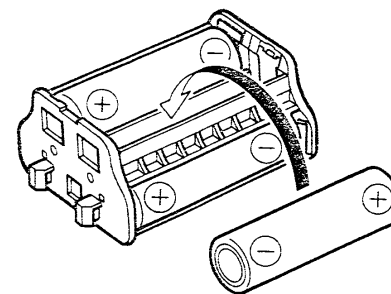

- ③ Insert the battery case into the transceiver until a click sounds.

■ Pre-operation

NOTE: For telephone operation, the OPB (Option Board) is required. Otherwise, only talk around operation is available. Ask your system operator or Icom Dealer for details.

Charge the battery pack before first operating the transceiver or when the battery pack becomes exhausted.

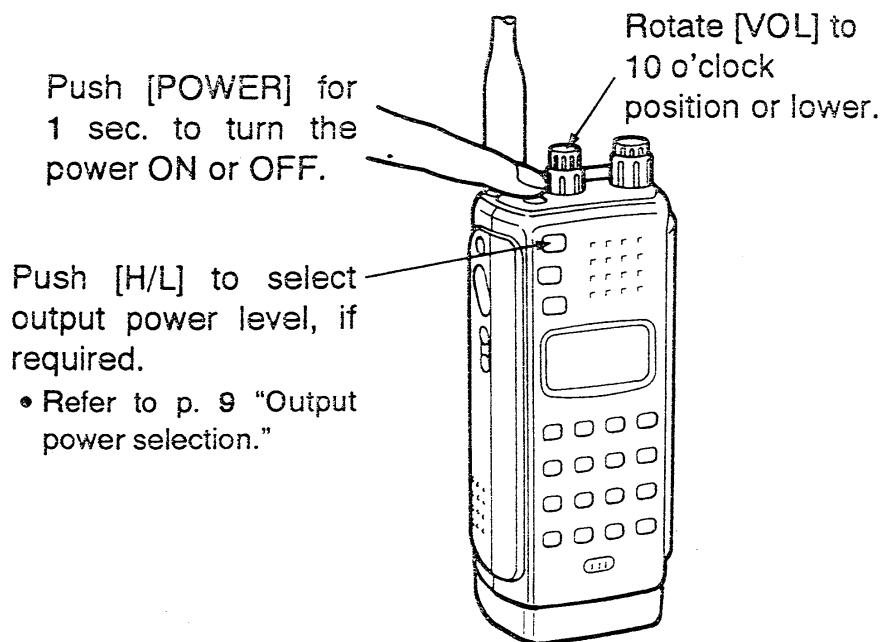

When the power cannot be turned OFF, remove the battery pack from the transceiver, then charge the battery pack.

■ Calling

- ① Input a telephone number using [1]–[0], [*] and [#].
 - When a digit is mistakenly input, push [C] to cancel.
 - "E" and "F" appear for [*] and [#], respectively.

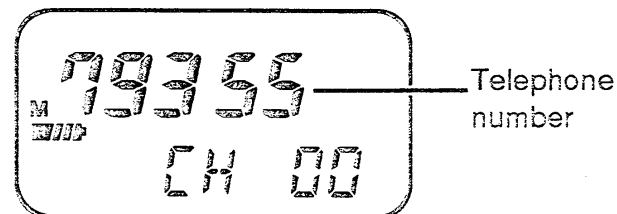

- ② Push [SND] to call.
 - "ON" appears and a telephone number is transmitted. A channel is automatically selected.
 - The transmit indicator lights up in red. The RF indicator shows the selected output power level.
- ③ Hold the transceiver like a telephone handset.
- ④ After the called party answers, begin communication.
 - If a busy signal is heard or there is no answer, push [SND] again to cancel the call.
- ⑤ Push [SND] again to end communication.

NOTE: Calling operation may differ from above. Ask your system operator or Icom Dealer for details.

DTMF memory operation

◇ DTMF memory channel programming

DTMF memory channels allow auto dialing. Up to 10 telephone numbers are programmable.

- ① Push [DTMF] to select DTMF MEMORY mode.
 - "DTMF" appears.
- ② Push [0]–[9] to select a DTMF memory channel from d0–d9.
- ③ Push [FUNC] + [8] to select the DTMF memory setting display.
 - "SET" appears.
- ④ Push keys in sequence for a telephone number.
 - Up to a 16-digit telephone number is programmable.
 - When a digit is mistakenly input, push [C], then input again.
- ⑤ Push [DTMF] to program the telephone number.
- ⑥ Push [A] to exit DTMF MEMORY mode.

◇ DTMF memory channel transmitting

Transmit DTMF memory channel contents as follows.

- ① Referring to the left, program DTMF memory channels in advance.
- ② Push [DTMF] to select DTMF MEMORY mode.
- ③ Push [0]–[9] to select a DTMF memory channel from d0–d9.
 - The DTMF memory channel contents appear.
 - To cancel DTMF MEMORY mode, push [A].
- ④ Push [SND] to call.
 - The DTMF memory channel contents are transmitted.

[Example] Programming "432725" into DTMF memory channel d5.

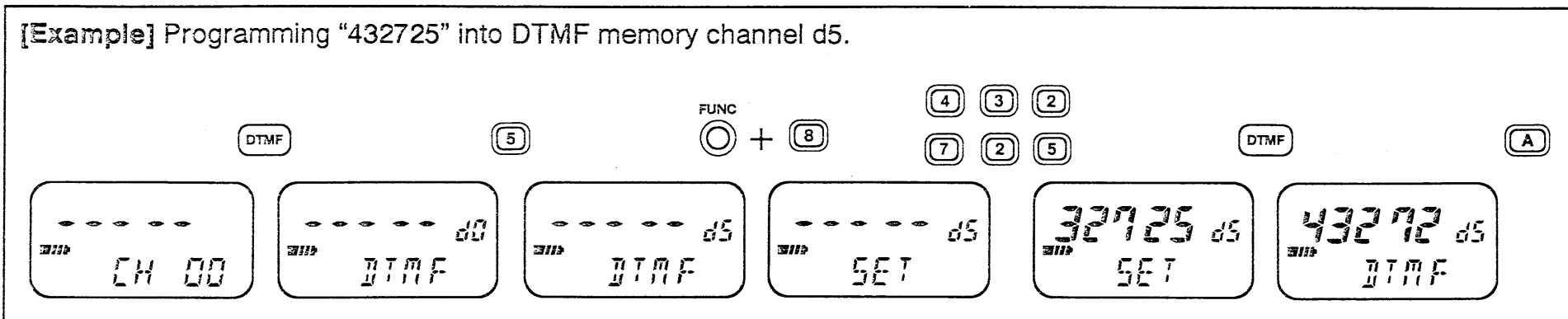

4 TELEPHONE OPERATION

■ Lighting

For easy operation at night, the function display and keyboard can be illuminated.

◇ 5 sec. timer

Push [LIGHT] to turn the lighting ON. The lighting automatically turns OFF after 5 sec. if the tuning dial, switch or keyboard are not operated. To turn OFF the lighting manually, push [LIGHT] again.

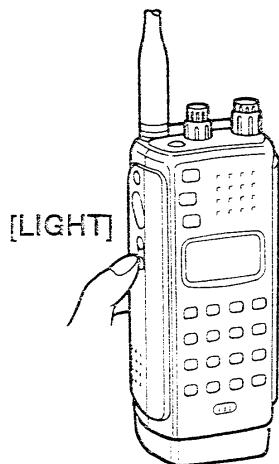

◇ Continuous lighting

Push [FUNC] + [LIGHT] to turn the lighting ON continuously. Push [LIGHT] to turn the lighting OFF.

- To conserve battery power, turn OFF the lighting after reading the function display.

■ Battery voltage indication

The battery capacity indicator "■|||■" graphically shows remaining dry cell battery capacity in the optional BP-159 BATTERY CASE.

Indication	■ ■ 4 seg.	□ ■ 3 seg.	□ ■ 2 seg.	□ 1 seg.
6.0 V ref. voltage	5.4 V or above (89–100%)	4.7–5.4 V (78–89%)	4.1–4.7 V (67–78%)	4.1 V or below (67% or below)

When only 1 segment "□||" appears, transmitting is impossible.

/// **NOTE:** When using the BP-151 or BP-152 BATTERY PACK, the battery voltage indicator appears, but is not useful. This is because unlike dry cell batteries, Ni-Cd battery' voltage drops sharply just before exhaustion.



■ Talk around communication

Talk around operation provides direct communication between transceivers. Steps ① and ② below are required only when the OPB (OPTION Board) is installed. Otherwise, turn the power ON normally.

- ① Turn the power OFF.
- ② While pushing [FUNC] + [A], push and hold [POWER] for 1 sec. to select talk around operation.

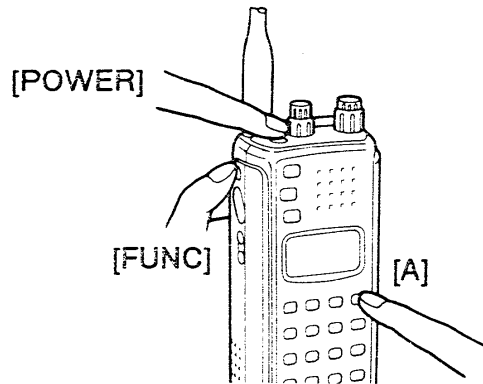

- ③ Rotate [DIAL] to set a talk around channel from T0 – T9.

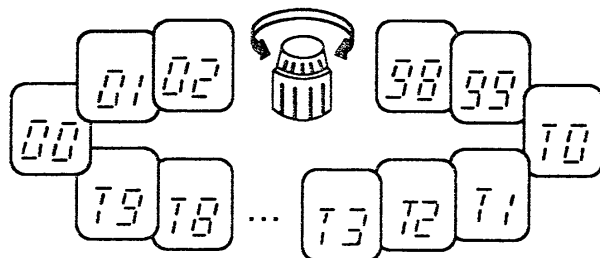

- ④ Rotate [VOL] to adjust audio output level.
- ⑤ Rotate [SQL] clockwise until the noise is quieted.
- ⑥ Push [H/L] to select the output power level, if required.
 - "LOW" appears when low output power is selected.
- ⑦ Push and hold [SND] to transmit.
 - The transmit indicator lights up in red. The RF indicator shows the selected output power level.
- ⑧ Speak into the microphone at your normal voice level.
 - **DO NOT** hold the transceiver too close to your mouth or speak too loudly. This may distort the signal.
- ⑨ Release [SND] to return to receive.
 - When a signal is received, the squelch opens and audio is heard. The transmit/receive indicator lights up in green.
- ⑩ Turn the power OFF to exit talk around operation.

NOTE:

- **DO NOT** use telephone channels 00 – 99 for talk around communication. Otherwise, your signal may interfere with other stations. Use talk around channels T0 – T9.
- Telephone channel numbers may differ from above. Ask your system operator or Icom Dealer for details.
- When [SQL] is set too far clockwise, the squelch may not open for weak signals.

5 TALK AROUND OPERATION

■ Monitor function

This function is used to listen to weak signals that repeatedly open and close the squelch. When receiving a weak signal, push and hold [MONI] to open the squelch completely.

■ Beep tones

The speaker emits beep tones each time a switch is operated. The beep tone can be cancelled, if required.

- ① Select talk around operation. (p. 12)
- ② Push [FUNC] + [8] to select SET mode.
 - "BEEP" appears.
- ③ Rotate [DIAL] to select "on" or "off."
 - "on" : The speaker emits beep tones.
 - "off" : The speaker does not emit beep tones.

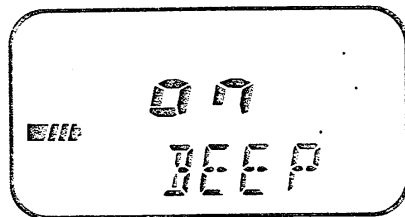

Initial setting

"on"

- ④ Push [A] to exit SET mode.

■ Scan operation

This function repeatedly scans channels sequentially. This is convenient when searching for signals.

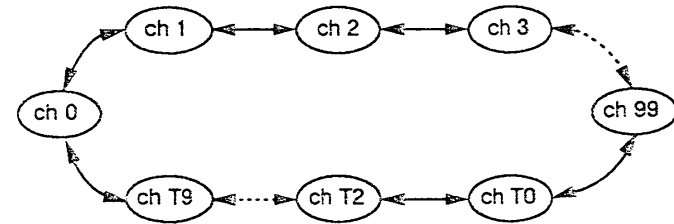

Ch 0 - 99: Telephone channels Ch T0 - T9: Talk around channels

- ① Select talk around operation. (p. 12)
- ② Rotate [SQL] clockwise until the noise is quieted.
- ③ Push [FUNC] + [#] to start the scan in the forward direction, or push [FUNC] + [*] for the reverse direction.
 - "S" appears while scanning.
 - To change the scanning direction, rotate [DIAL].
- ④ To cancel the scan, push [A].
 - "M" appears when the scan is cancelled.

◇ When a signal is received

Scan pauses on the channel until the signal disappears and then resumes 2 sec. after that.

/// **NOTE:** Telephone channel numbers may differ from above. Ask your system operator or Icom Dealer for details.

Code setting

◇ What is the pager function?

This selective calling function informs you of a caller's ID code even if you leave the transceiver.

◇ What is the code squelch function?

This selective calling function receives calls only from stations which know your ID code or group code.

◇ Before programming

The pager and code squelch functions require 3-digit ID codes and a group code.

◇ Code channel assignment

ID or group code	Code channel number	"Receive accept" or "receive inhibit"
Your ID code	C0	"Receive accept" only.
Other parties' ID code	C1-C5	"Receive inhibit" should be programmed in each channel.
Group code	One of C1-C5	"Receive accept" must be programmed.
Memory space*	CP	"Receive inhibit" only.

* Code channel CP automatically memorizes an ID code when receiving a pager call. The contents in channel CP cannot be changed manually.

Code channel programming

- ① Push [FUNC] + [5] to select the code channel setting display.

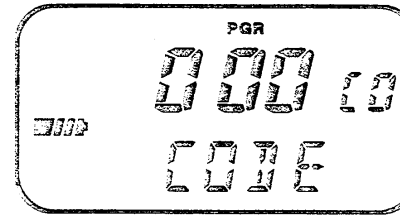

- ② Rotate the tuning dial to select a code channel from C0-C5.
- ③ Push the numeral keys to enter the desired 3-digit code.
 - Digits are automatically stored when the 3rd digit is entered.
 - When a digit is mistakenly input, enter the desired code from the beginning.
- ④ Push [FUNC] + [3] to set the channel for "receive inhibit" or "receive accept."
 - When "receive inhibit" is set, "SKIP" appears.

Code channel that contain a group code	Must be programmed as "receive accept" to receive all calls from group members.
Code channels that contain other parties' ID codes	Should be programmed as "receive inhibit." Otherwise, the transceiver accepts calls directed to other parties.

- ⑤ Push [A] to exit the setting display.

6 PAGER AND CODE SQUELCH

■ Pager operation

This function can be used as a “message pager” to inform you of calls even if you leave the transceiver temporarily.

◇ Calling

- ① Push [FUNC] + [2] 1 time.
 - “PGR” appears.

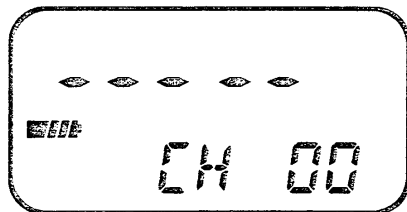

- ② Push [FUNC] + [5].
- ③ Rotate [DIAL] to select a code channel from C1 – C5.

Personal call	Select a code channel that contains receiving parties' ID code.
Group call	Select a code channel that contains your group code. You can call all stations in your group.

- ④ Push [A].
- ⑤ Push [SND] to transmit the pager code.
 - After the pager code is transmitted, the pager function is automatically cleared.
- ⑥ Operate the transceiver in the normal way.

◇ Waiting for a call from a specific station

- ① Push [FUNC] + [2] 1 time.
 - “PGR” appears.
- ② Wait for a call.

When your ID code is received	The calling parties' ID code appears.
When your group code is received	The group code appears.

- After your ID code or group code is received, the pager function is automatically cleared.
- ③ Operate the transceiver in the normal way.

■ Code squelch operation

This function allows you to receive calls only from stations which know your ID code or group code.

- ① Push [FUNC] + [2] 2 times.
 - “C SQL” appears.
- ② Push [FUNC] + [5].
- ③ Rotate [DIAL] to select a code channel from C1 – C5.
- ④ Push [SND] to transmit the code squelch code.
 - After a code squelch code is transmitted or received, the code squelch function is automatically cleared.
- ⑤ Operate the transceiver in the normal way.

◇ Battery packs and carrying case

Battery pack	Height with transceiver	Voltage	Capacity	Carrying case
BP-151	111 mm; 4.4 in	6.0 V	800 mAh	LC-109
BP-152	126.8 mm; 5.0 in	6.0 V	1100 mAh	LC-111
BP-159	111 mm; 4.4 in	Battery case for R6 (AA) × 4		LC-109

NEVER use the BP-153 BATTERY PACK. This 12 V battery pack will ruin the transceiver.

NEVER attempt to charge the BP-159 BATTERY CASE when dry cell batteries are installed. Otherwise, battery leakage may occur.

◇ Chargers and battery pack adapter

BC-74A/E/D/V WALL CHARGER

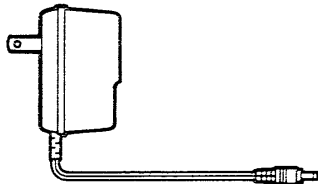

Regularly charges the BP-151 or BP-152 through a transceiver.

Charging time: 15 hrs.

BC-79 WALL CHARGER + AD-44 BATTERY PACK ADAPTER

BC-79

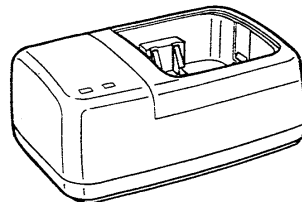

Rapidly charges the BP-151 or BP-152.

**Charging time: BP-151 75 min.
BP-152 70 min.**

AD-44A

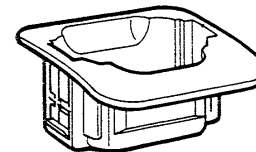

AD-44B

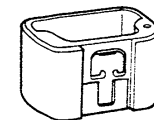

The AD-44 consists of the AD-44A and AD-44B. The AD-44A is attached to the BC-79. The AD-44B allows you to charge the BP-151 or BP-152 alone.

ICOM

产品使用说明

VHF FM TRANSCEIVER

IC-T21CP

UHF FM TRANSCEIVER

IC-T31CP

Icom Inc.

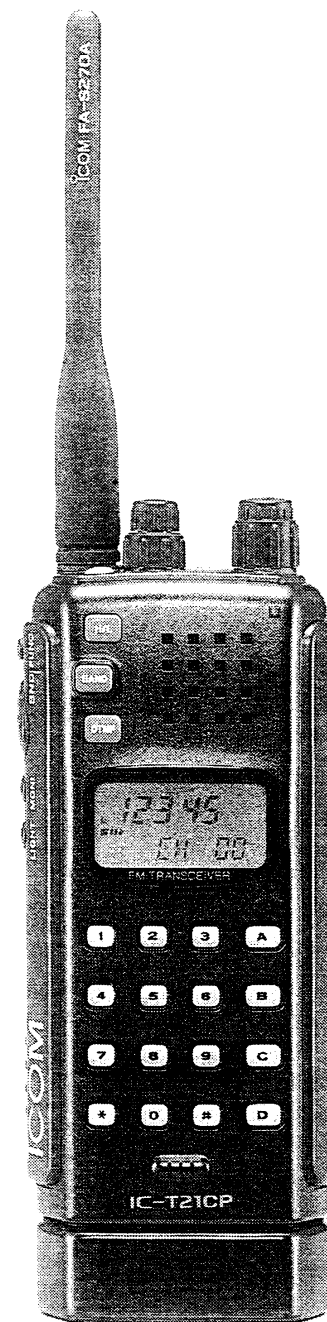

重要事项

使用对讲机之前，请认真通读本使用说明书。

妥善保管使用说明书。本使用说明书记载了有关安全和操作的重要事项。

用于电话操作时，需要任选卡（OPB）。否则，仅适用于对讲操作。详情请惠询系统操作人员或爱康姆公司代销店。

开封

- ①手提带 1
- ②柔性天线（FA-S270A）..... 1
- ③皮带夹和螺钉 1套

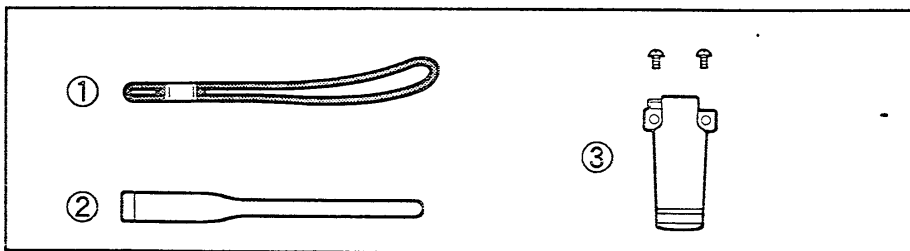

BP-152电池包连接在对讲机主机上。

注意事项

切勿将对讲机接至交流电源插座。否则将会损坏对讲机。

切勿让幼儿触摸对讲机。

不得在墙挂型充电器被接至顶部操作盘的 [DC13.5V] 时打开电源。因为此插孔仅用于充电。

避免将对讲机放在温度低于 -10°C 或高于 $+60^{\circ}\text{C}$ 的环境中。

避免将对讲机放在直射阳光下。

注意！在高输出功率下长时间使用对讲机时，后面板将会发热。

注意！使用爱康姆牌以外的电池包和充电器时，将会有碍对讲机性能，且此情况不属保修范围。

目录

重要事项.....	i	4 电话操作.....	8~11
开封.....	i	■操作准备.....	8
注意事项.....	i	■呼叫.....	8
目录.....	ii	■回答.....	9
1 操作盘说明.....	1~4	■输出功率的选择.....	9
■前面操作盘和侧面操作盘.....	1	■重拨号.....	9
■键盘.....	2	■DTMF记忆操作.....	10
■顶部操作盘和后部操作盘.....	3	■照明.....	11
■功能显示屏.....	4	■电池电压指示.....	11
2 附件.....	5	5 对讲操作.....	12~15
3 电池包充电.....	6~7	■对讲通话.....	12
■可使用的电池包.....	6	■监听功能.....	13
■充电连接.....	6	■按键提示音.....	13
■电池包使用注意事项.....	7	■扫描操作.....	13
■干电池装入方法.....	7	6 寻呼和编码静噪.....	14~15
		■编码的设定.....	14
		■编码信道的编程.....	14
		■寻呼操作.....	15
		■编码静噪操作.....	15
		7 任选附件.....	16

操作盘说明

■前面操作盘和侧面操作盘

功能开关 [FUNC]

持续按下时，配合其它开关执行2次功能。
“按下 [FUNC] + 某一开关“表示” 按住 [FUNC] 的同时，按下该开关”。

发射开关 [SND]

—电话操作时：呼叫或回答时按下此开关。
再按一下便结束通话。(参看第8、9页)
—对讲操作时：按下则传送，松开则接收。
(参看第12页)

监听开关 [MONI]

—电话操作时：不起作用。
—对讲操作时：监听操作的信道。(参看第13页)

照明开关 [LIGHT]

用于打开和关闭照明。(参看第11页)

键盘(参看第2页)

传送/接收指示灯

—电话操作时：通话时红灯点亮(参看第8页)
—对讲操作时：传送时红灯点亮，接收时绿灯点亮。(参看第12页)

高/低开关 [H/L]

用于选择大小输出功率电平。
(参看第8、12页)

扬声器

波段开关 [BAND]

不起作用。

DTMF开关 [DTMF]

用于选择DTMF记忆模式。(参看第10页)

功能显示屏 (参看第4页)

麦克风

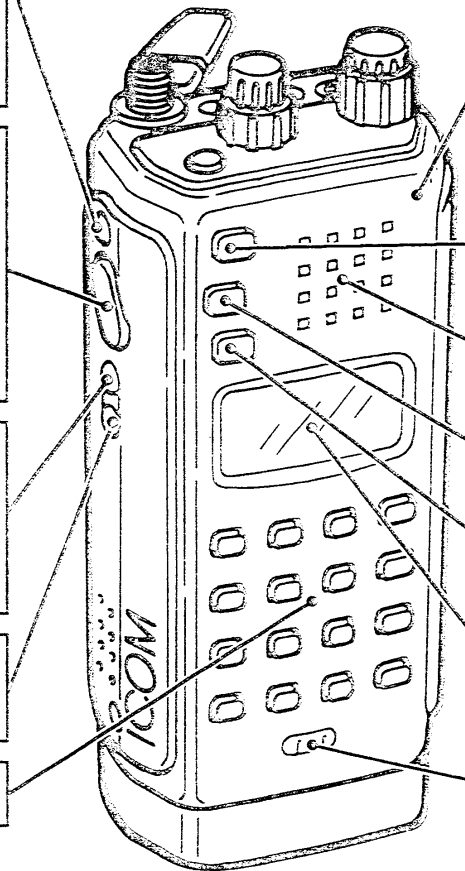

■ 键盘

◇ 电话操作时

键	功能
	—输入电话号码。(参看第8页) —DTMF记忆模式时：选择DTMF记忆信道。(参看第10页)
	—取消重拨号功能。(参看第9页) —退出DTMF记忆模式。(参看第10页)
	取消电话号码。(参看第8页)
	允许重拨号。(参看第9页)
	DTMF记忆模式时：允许DTMF记忆信道编程。(参看第10页)

注：用于电话操作时，需要任选卡(OPB)。否则，仅适用于对讲操作。详情请惠询系统操作人员或爱康姆公司代销售店。

◇ 对讲操作时

键	功能
	编码信道设定显示时： 用于编码信道编程。(参看第14页)
	启动或取消寻呼或编码静噪功能。(参看第15页)
	编码信道设定显示时：设定“拒绝接收”或“同意接收”用编码信道。(参看第14页)
	选择寻呼或编码静噪用编码信道设定显示。(参看第14、15页)
	选择SET模式以打开或关闭按键提示音。(参看第13页)
	启动正向扫描。(参看第13页)
	启动反向扫描。(参看第13页)
	—退出SET模式。(参看第13页) —取消扫描。(参看第13页) —退出编码信道设定显示。(参看第14、15页)

1 操作盘说明

■ 顶部操作盘和后部操作盘

充电插孔 [DC13.5V]

连接选购附件的定期充电用BC-74A/E/D/V墙挂型充电器。(参看第6页)

注意：

不得在充电时接通对讲机电源。这个插孔仅用于充电。

不得在利用选购附件的BP-159电池盒使用干电池进行操作的状态下连接墙挂型充电器。否则，可能造成电池液外漏。

天线连接器

SMA-型连接器。连接标准附件的天线。(参看第5页)

电源开关 [POWER]

—接通和切断对讲机电源。(参看第8页)
—接通电源开关时，按下 [FUNC] + [A]：选择对讲操作。(参看第12页)

电池包解除钮

(参看第7页)

外接扬声器和麦克风插孔 [SP]、[MIC]

不使用

提示：不得在电话操作时使用任一外接装置。

调谐度盘 [DIAL]

—电话操作时：不起作用。

—对讲操作时：选择信道。(参看第12页)

音量调节钮 [VOL]

调节音频电平。(参看第8、12页)

静噪控制钮 [SQL]

—电话操作时：不起作用。

—对讲操作时：调节静噪电平。(参看第12页)

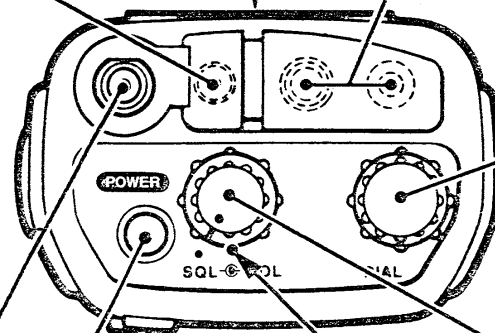

■功能显示屏

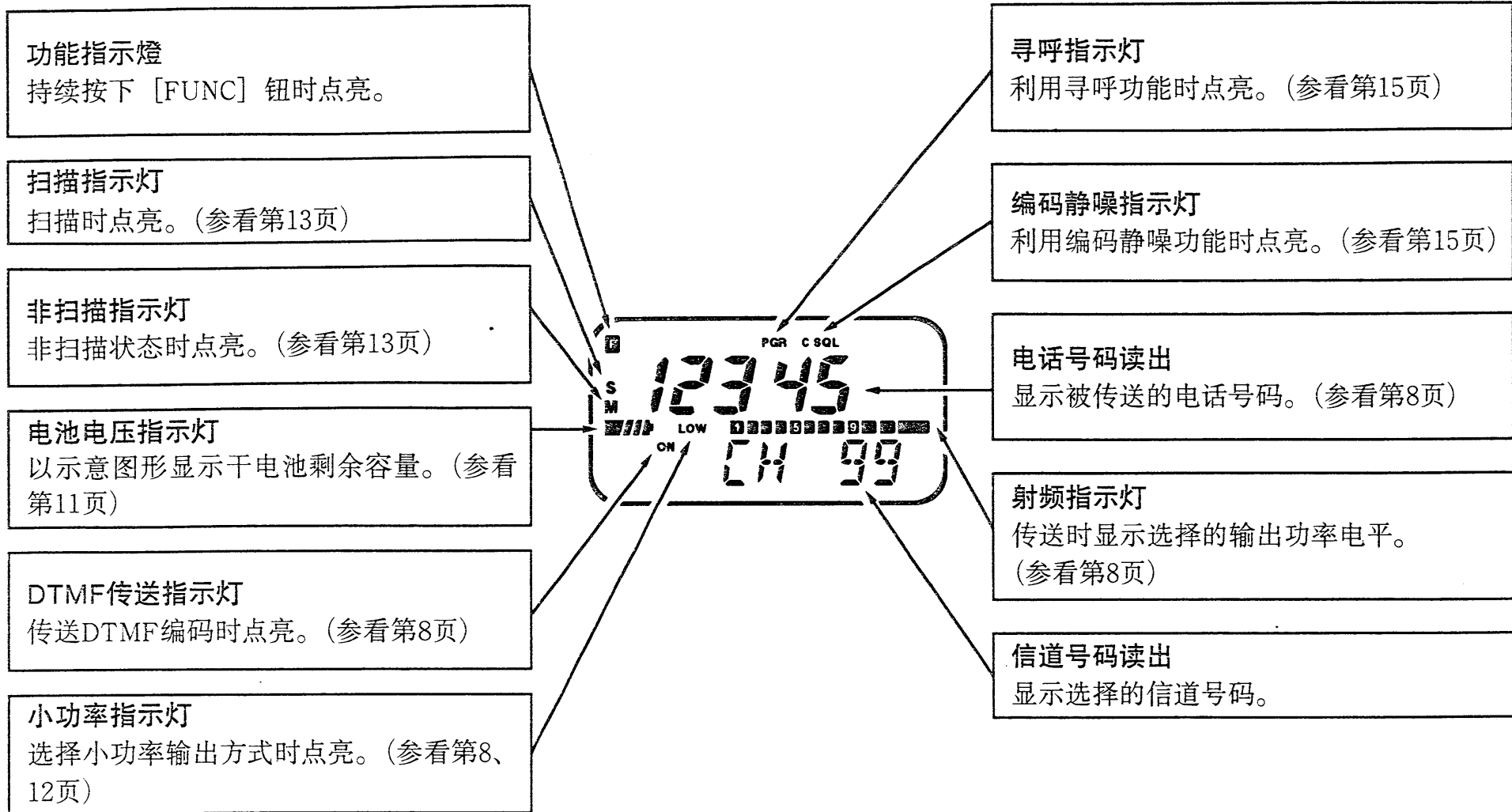

◇天线

将附属的天线插入天线连接器中，用螺钉旋紧。

不使用插孔时，要盖上插孔罩，以免损伤触点。

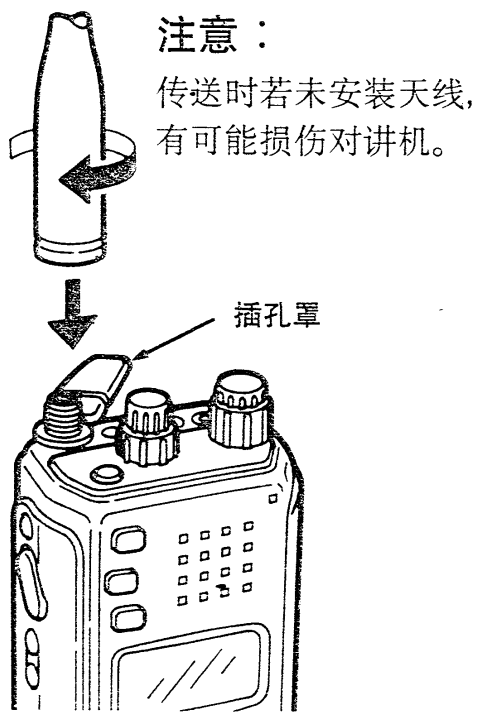

◇手提带

将手提带装在附属的皮带夹上。手提带便于携带。

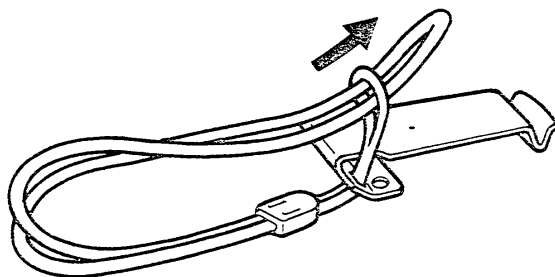

◇皮带夹

卸下塑料螺钉，然后用附属的金属螺钉安装皮带夹。利用皮带夹可方便地挂在腰间皮带上。

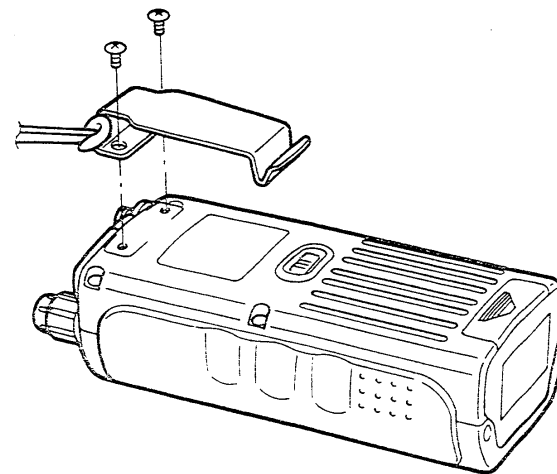

■可使用的电池包

对讲机可使用BP-151、BP-152电池包和BP-159电池盒。
(参看第16页)

注意：不得使用BP-153电池包。这种12伏的电池包将会损坏对讲机。

■充电连接

◇定期充电

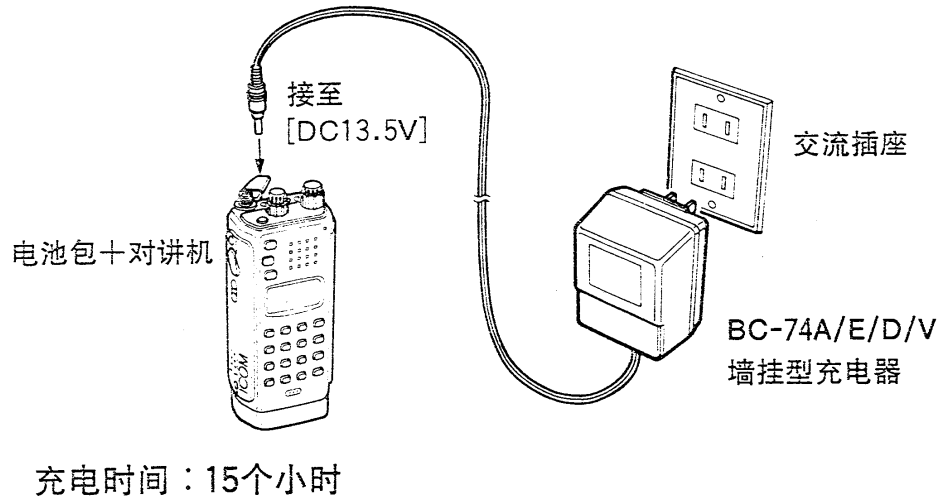

提示：

- 不得在充电时接通对讲机电源。顶部操作盘上的 [DC 13.5V] 仅用于充电。
- 不得在连接选购附件BP-159电池盒的状态下连接墙挂型充电器。否则，可能造成电池液外漏。
- 充电时间不要超过48个小时，以免充电过度。

◇快速充电

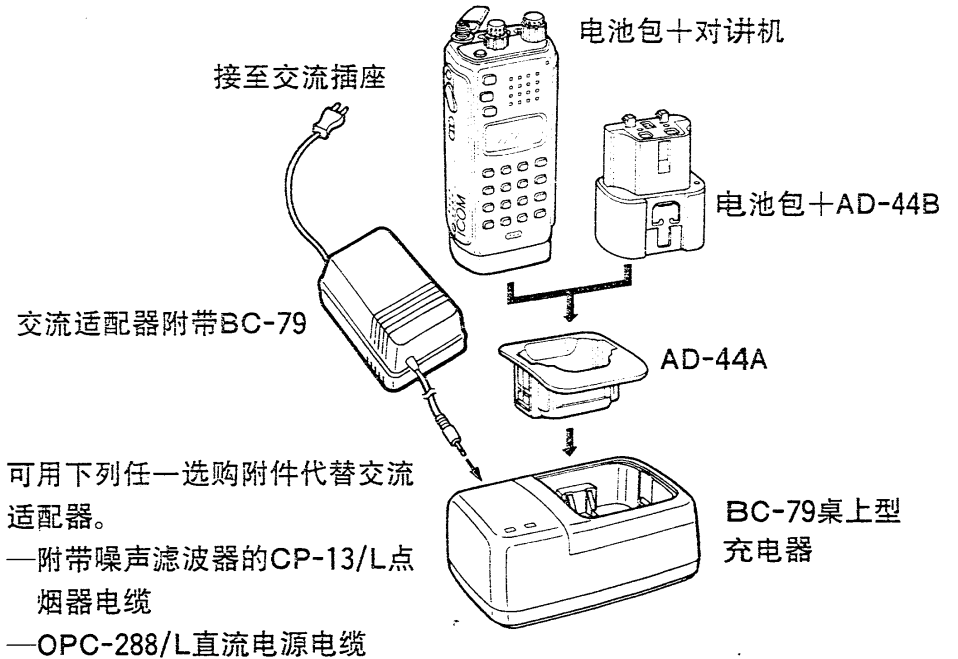

充电时间：BP-151为75分钟，BP-152为70分钟。

3 电池包充电

■ 电池包使用注意事项

不得将电池包投入火中。

不得让电池包溅到水。

不得使金属端子短路。

不得试图对装有干电池的选购附件BP-159电池盒进行充电。否则，可能造成电池液外漏。

在极冷（0℃以下）或极热（40℃以上）环境中，有可能不能充满电。

◇ 电池包合理使用方法

充电后的电池包容量不足时，可在接通对讲机电源的状态下放置一夜，使其充分放电。然后再重新充电。若容量仍不足时，则要更换新电池包。

电池包约可充电300次，但若遵守下列事项，电池包充电次数可达500次左右：

—避免充电过度。

—在正常状态下使用电池包直至接近全部放电。当传送不能时便马上充电。

■ 干电池装入方法

利用选购附件BP-159电池盒，可使用干电池操作对讲机。

①从对讲机上卸下电池盒。

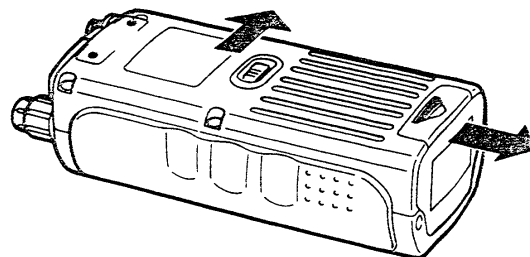

②装入AA（R6）型4节干电池。

● 注意不要搞错极性。

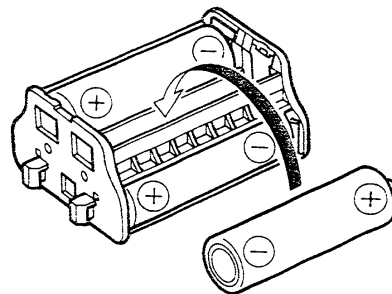

③将电池盒插入对讲机中，直至发出卡嗒声。

操作准备

提示：用于电话操作时，需要任选卡（OPB）。否则，仅适用于对讲操作。详情请惠询系统操作人员或爱康姆公司代销店。

初次使用对讲机前或电池包已全部放电后，要对电池包充电。

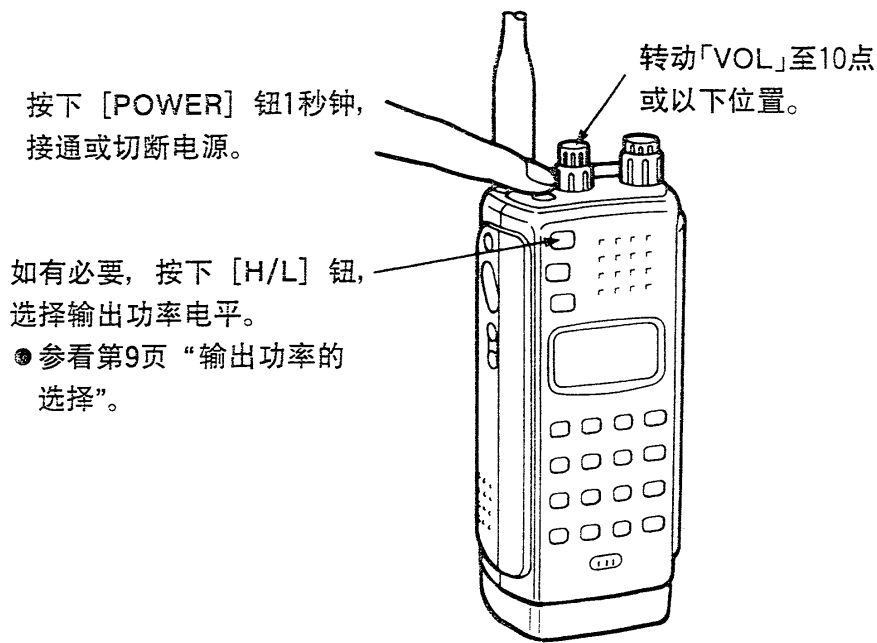

当不能切断电源时，可从对讲机中卸下电池包，然后对电池包进行充电。

呼叫

- ①用 [1] ~ [0]、[*] 及 [#] 键输入电话号码。
 - 输入的数字有误时，可按下 [C] 钮取消。
 - 显示“E”和“F”分别表示 [*] 和 [#]。

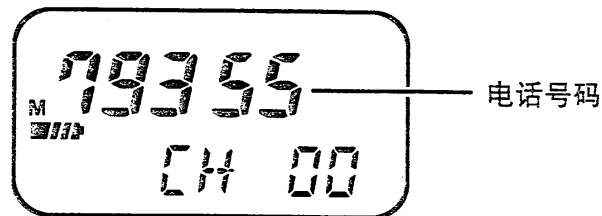

- ②按下 [SND] 钮呼叫。
 - 显示“ON”并传送电话号码。此时，自动选择一个信道。
 - 红色传送指示灯点亮。射频指示灯显示选择的输出功率电平。
- ③像电话机的话筒一样握住对讲机。
- ④被呼叫的一方回答后，便开始通话。
 - 若听到占线音或无回答，要再按一下 [SND] 钮取消呼叫。
- ⑤结束通话时，再按一下 [SND] 钮。

提示：呼叫操作方法有时与上述不同。详情请惠询系统操作人员或爱康姆公司代销店。

4 电话操作

■ 回答

- ①被呼叫时，按下 [SND] 钮开始回答。
 - 红色传送指示灯点亮。射频指示灯显示选择的输出功率电平。
- ②像电话机的话筒一样握住对讲机。
- ③开始通话。
- ④结束通话时，再按一下 [SND] 钮。

提示：回答操作方法有时与上述不同。详情请惠询系统操作人员或爱康姆公司代商店。

■ 输出功率的选择

如有必要，可选择大功率输出或小功率输出。小功率输出时的使用时间长，但通话范围窄。

按下 [H/L] 钮选择输出功率电平。

- 选择了小功率输出时，显示“LOW”。

	射频指示灯	输出功率	
		IC-T21CP	IC-T31CP
大功率		1.5瓦	1.5瓦
小功率		500毫瓦	700毫瓦

■ 重拨号

重拨号存储信道可重拨最后一次在功能显示屏上输入的电话号码。

- ①按下 [D] 钮。
 - 要取消重拨号时，按下 [A] 钮。

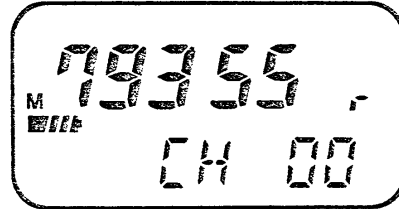

- ②按下 [SND] 钮，呼叫显示的电话号码。

■DTMF记忆操作

◇DTMF记忆信道的编程

DTMF记忆信道可自动拨号。可编入程序的电话号码达10个。

- ①按下 [DTMF] 钮，选择DTMF记忆模式。
 - 显示“DTMF”。
- ②按下 [0]～[9] 键，从d0～d9中选择DTMF记忆信道。
- ③按下 [FUNC] + [8] 键，选择DTMF记忆设定显示。
 - 显示“SET”。
- ④顺次输入电话号码。
 - 最多可输入16位数的电话号码。
 - 输入的数字有误时，按下 [C] 钮后重新输入。
- ⑤按下 [DTMF] 钮，编设电话号码。
- ⑥按下 [A] 钮，退出DTMF记忆模式。

◇DTMF记忆信道的传送

如下传输DTMF记忆信道。

- ①按照左侧步骤，预先进行DTMF记忆信道的编程。
- ②按下 [DTMF] 钮，选择DTMF记忆模式。
- ③按下 [0]～[9] 键，从d0～d9中选择DTMF记忆信道。
 - 显示DTMF记忆信道内容。
 - 要取消DTMF记忆模式时，按下 [A] 钮。
- ④按下 [SND] 钮，开始呼叫。
 - DTMF记忆信道内容即被传送。

[示例] 将“432725”编设到DTMF记忆信道d5中。

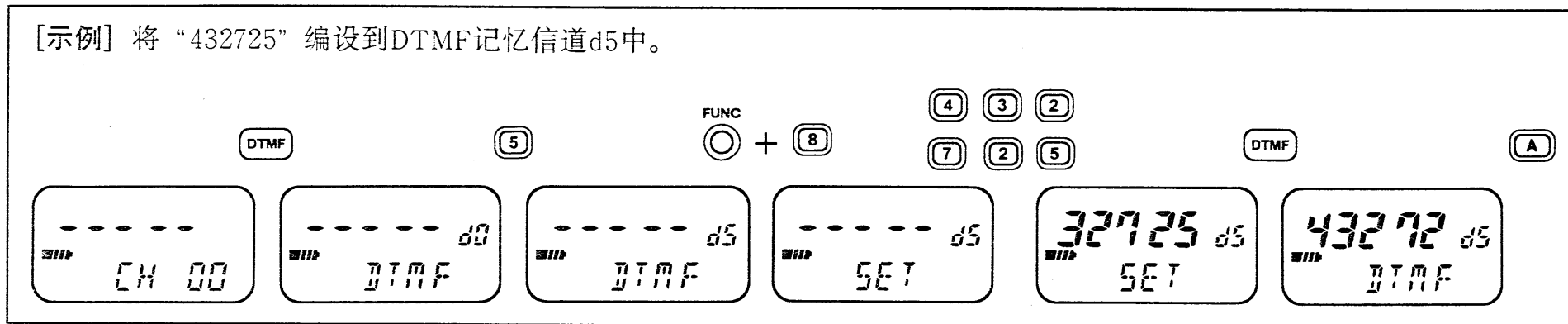

4 电话操作

■照明

为便于夜间操作，功能显示屏和键盘能被照亮。

◇5秒钟照明定时器

按下 [LIGHT] 钮，点亮照明灯。若5秒钟内未操作调谐度盘、开关或键盘，则照明将自动熄灭。要手动关闭照明灯时，再按一下 [LIGHT] 钮。

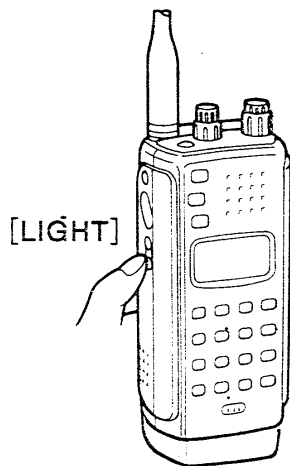

◇连续照明





按下 [FUNC] + [LIGHT] 钮，连续点亮照明灯。

按下 [LIGHT] 钮，关闭照明灯。

●为节省电池消耗量，读出功能显示屏的显示后，应关闭照明灯。

■电池电压指示

电池容量指示灯“”以示意图形显示选购附件BP-159电池盒中的干电池剩余容量。

指 示	 4节	 3节	 2节	 1节
标准电压 6.0伏	5.4伏或5.4伏以上 (89~100%)	4.7~5.4伏 (78~89%)	4.1~4.7伏 (67~78%)	4.1伏或4.1伏以下 (67%或67%以下)

如仅显示1节“”时，则便无法传送。

提示：使用BP-151或BP-152电池包时，电池电压指示灯虽然也点亮，但不起作用。这是因为与干电池不同，镍镉电池的电压在耗尽前一刻会急剧下降。

■ 对讲通话

对讲话操作用于对讲机之间的直接通话。下列步骤①和②仅在装有任选卡 (OPB) 时才有必要操作。否则, 可按照通常步骤接通电源。

- ① 切断对讲机电源。
- ② 按下 [FUNC] + [A] 钮的同时, 按住 [POWER] 钮1秒钟, 选择对讲操作。

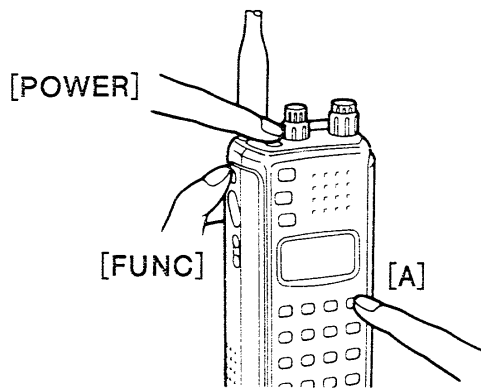

- ③ 转动 [DIAL] 钮, 从T0~T9中设定对讲信道。

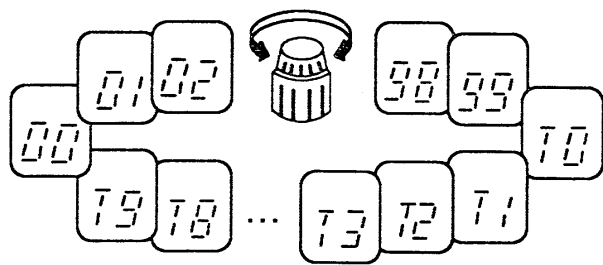

- ④ 转动 [VOL] 钮, 调节音频输出电平。
- ⑤ 顺时针方向转动 [SQL] 钮, 直至噪声消失。
- ⑥ 如有必要, 按下 [H/L] 钮, 选择输出功率电平。
 - 选择小功率输出时, 显示“LOW”。
- ⑦ 持续按下 [SND] 钮, 开始传送。
 - 红色传送指示灯点亮。射频指示灯显示选择的输出功率电平。
- ⑧ 用通常的语调对着麦克风讲话。
 - 对讲机不得过于贴近嘴, 讲话声音也不要过大, 否则可能导致信号失真。
- ⑨ 松开 [SND] 钮, 转为接收。
 - 接收到信号时, 静噪电路开放, 同时听到声音。绿色传送/接收指示灯点亮。
- ⑩ 要退出对讲操作方式时, 切断对讲机电源。

提示：

- 对讲通话时应使用对讲信道T0~T9, 不得使用电话信道00~99。否则, 将会干扰其它通信站。
- 电话信道号码可能与上述不同。详情请惠询系统操作人员或爱康姆公司代商店。
- [SQL] 钮顺时针转动过大时, 有时微弱信号不能使静噪电路开放。

5 对讲操作

■ 监听功能

这种功能通过反复开放和关闭静噪电路来收听微弱信号。当接收微弱信号时，持续按下 [MONI] 钮，使静噪电路完全开放。

■ 按键提示音

每次操作开关时，扬声器都发出按键提示音。如有必要，可取消按键提示音。

- ①选择对讲操作方式。（参看第12页）
- ②按下 [FUNC] + [8] 钮选择设定模式。
 - 显示“BEEP”。
- ③转动 [DIAL] 钮，选择“on”或“OFF”。
 - “on”：扬声器发出按键提示音。
 - “OFF”：扬声器不发出按键提示音。

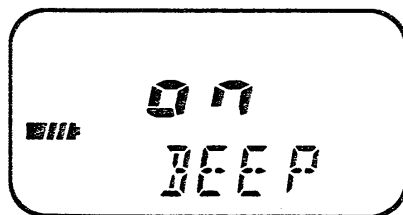

初始设定状态

“on”

- ④按下 [A] 钮，退出设定模式。

■ 扫描操作

这种功能可反复顺次扫描信道。检索信号时，利用这种功能很方便。

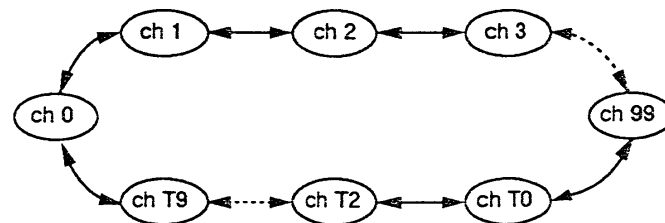

信道0~99：电话信道 信道T0~T9：对讲信道

- ①选择对讲操作方式。（参看第12页）
- ②顺时针方向转动 [SQL] 钮，直至噪声消失。
- ③按下 [FUNC] + [#] 钮开始正向扫描，或按下 [FUNC] + [*] 钮开始反向扫描。
 - 扫描时显示“S”。
 - 要改变扫描方向时，可转动 [DIAL] 钮。
- ④要取消扫描时，按下 [A] 钮。
 - 取消扫描后，显示“M”。

◇ 接收到信号时

扫描在信道上暂停，直至信号消失，然后待2秒钟便恢复扫描。

提示：电话信道号码可能与上述不同。详情请惠询系统操作人员或爱康姆公司代销店。

■ 编码的设定

◇ 何谓寻呼功能?

这种选择性呼叫功能，当被呼叫时您不在对讲机旁，也可留下呼叫者的识别码。

◇ 何谓编码静噪功能?

这种选择性呼叫功能，只能接收知道您的识别码或组呼码的通信站发出的呼叫。

◇ 编程之前

寻呼和编码静噪功能需要3位数识别码和1位数组呼码。

◇ 编码信道分配

识别或组呼码	编码信道号码	“同意接收”或“拒绝接收”
您的识别码	C0	仅用于“同意接收”。
其它通信组识别码	C1~C5	应在每一信道中进行“拒绝接收”编程。
组呼码	C1~C5中的一个	必须进行“同意接收”编程。
存储空间*	CP	仅用于“拒绝接收”。

*当接收寻呼的呼叫后，编码信道CP自动记忆一个识别码。
不能用手动转换信道CP中的内容。

■ 编码信道的编程

①按下 [FUNC] + [5] 钮，选择编码信道设定显示。

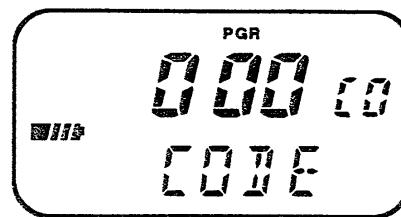

②转动调谐度盘，从C0~C5中选择一个编码信道。

③按下数字键，输入任意的3位数编码。

- 输入第3个数字后，该3位数便被自动存储。
- 输入的数字有误时，可重新输入任意的编码。

④按下 [FUNC] + [3] 钮，设定“拒绝接收”或“同意接收”用信道。

- 设定“拒绝接收”后，显示“SKIP”。

含有组呼码的编码信道	必须设定“同意接收”，以接收组呼成员的全部呼叫。
含有其它通信组识别码的编码信道	应设定“拒绝接收”。否则，对讲机将直接呼叫另一方。

⑤按下 [A] 钮，退出设定显示方式。

6 寻呼和编码静噪

■ 寻呼操作

这种功能用于“留言寻呼”，当被呼叫时您不在对讲机旁，也可知道有人呼叫您。

◇ 呼叫

① 按一下 [FUNC] + [2] 钮。

- 显示“PGR”。

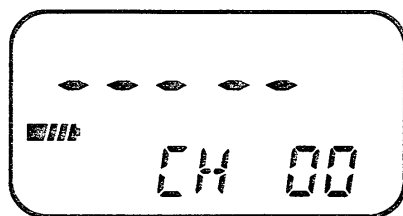

② 按下 [FUNC] + [5] 钮。

③ 转动 [DIAL] 钮，从C1~C5中选择编码信道。

个别呼叫	选择含有接收其它通信组识别码的编码信道。
组呼	选择含有您的组呼码的编码信道。 您可呼叫所在小组中的所有通信站。

④ 按下 [A] 钮。

⑤ 按下 [SND] 钮，传送寻呼码。

- 传送寻呼编码后，寻呼功能被自动清除。

⑥ 按照通常步骤操作对讲机。

◇ 等待特定通信站的呼叫

① 按一下 [FUNC] + [2] 钮。

- 显示“PGR”。

② 等待呼叫

当接收到您的识别码时	显示呼叫一方的识别码。
当接收到您的组呼码时	显示组呼码。

- 接收到您的识别码或组呼码后，寻呼功能被自动清除。

③ 按照通常步骤操作对讲机。

■ 编码静噪操作

利用这种功能只可接收知道您的识别码或组呼码的通信站发出的呼叫。

① 按二下 [FUNC] + [2] 钮。

- 显示“C SQL”。

② 按下 [FUNC] + [5] 钮。

③ 转动 [DIAL] 钮，从C1~C5中选择编码信道。

④ 按下 [SND] 钮，传送编码静噪码。

- 传送或接收编码静噪码后，编码静噪功能被自动清除。

⑤ 按照通常步骤操作对讲机。

◇ 电池包和便携盒

电池包	连同对讲机的高度	电压	容量	便携盒
BP-151	111毫米 (4.4英寸)	6.0伏	800毫安时	LC-109
BP-152	126.8毫米 (5.0英寸)	6.0伏	1100毫安时	LC-111
BP-159	111毫米 (4.4英寸)	R6(AA) × 4节用电池盒		LC-109

不得使用BP-153电池包。12伏电池包将会损坏对讲机。

不得对装有干电池的BP-159电池盒进行充电。否则，可造成电池液外漏。

◇ 充电器和电池包适配器

BC-74A/E/D/V墙挂型充电器

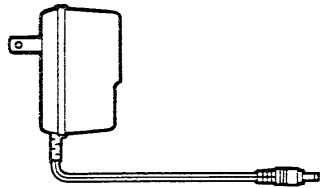

经对讲机对BP-151或BP-152进行定期充电。

充电时间：15个小时

BC-79墙挂型充电器 + AD-44电池包适配器

BC-79

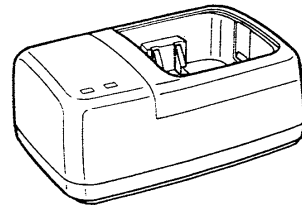

BP-151或BP-152快速充电用。

充电时间：BP-151为75分钟
BP-152为70分钟

AD-44A

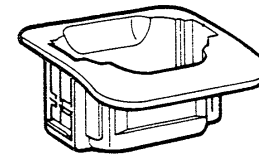

AD-44B

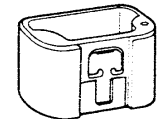

AD-44分为AD-44A和AD-44B。AD-44A用于连接BC-79。AD-44B可单独用于BP-151或BP-152的充电。

Count on us!

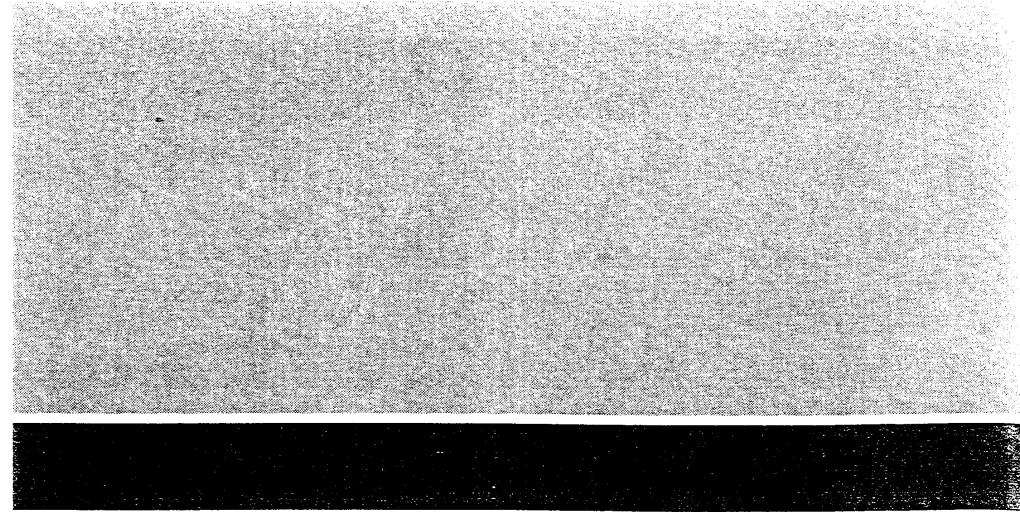

A-5304S-1CH
Printed in Japan
Copyright © 1994 by Icom Inc.

Icom Inc.
6-9-16, Kamihigashi, Hirano-ku, Osaka 547, Japan